

**ShoreStation**<sup>®</sup>

At the forefront of shorefront since 1959

BOAT LIFTS



# Simple and swift from launch to lift.

*The ease of speed*

*Sure, a ShoreStation lift is one of the fastest on the market, but it's more than that. The unmatched speed, versatility and dependability translates to more time on the water.*

*From the effortless centering of the load guides, to the reliable confidence of the boat stops, to the unmatched ease of the ShoreScreen, ShoreStation allows you to focus on the reason you came to the water in the first place ...to relax and enjoy.*

**SEE THE LIFT IN ACTION**



## Worry Free Landing

*Bring your boat to a perfect position every time with ShoreStation's system of quality products. Our bow and motor stops help prevent you from overrunning the lift, while our boat guides allow for an easy entrance even in wind and waves.*



## Convenient Wireless Operation

*ShoreStation has everything you need to create the custom waterfront of your dreams. Raise and lower your ShoreStation® Hydraulic Lift or ShoreScreen with this handy remote transmitter. Two come standard with all powered lifts.*

## Solar Battery Charging System

*Never miss another moment on the water. Power your lift with clean, free solar power. Our speedy 20 watt charger features solar regulator drainage protection, saving your battery from permanent damage caused by overcharging.*



## Maximum Protection for Your Boat and Lift

*Our patented hydraulic boat lift design not only gives you the confidence to load or lower your boat in rough water, but the 'high and dry' design keeps key components above the water. This translates to significantly less downtime, less maintenance and more summer fun time.*

## Quickly Secures Boat

*Made from the highest quality materials—including marine grade aluminum and 300 series stainless steel—our innovative hydraulic boat lift is one of the fastest and safest lifts on the market today. When you have a hydraulic lift, there's no need to worry about wind and waves getting in your way. This lift will give you confidence to safely land and secure your boat in less than ideal conditions.*



# Safe. Simple. Solar.

*ShoreStation's solar-powered systems harness the sun's energy to power your boat lift, making your lift more cost-effective, efficient and maintenance-free.*

## **SOLAR BATTERY CHARGING SYSTEM**

*Power the lift with clean, free solar power. The speedy 20 watt charger features a solar regulator to prevent battery drain and to protect your battery from permanent damage caused by overcharging.*



**CONVENIENCE & SAFETY** - Skip the electricity - it's simple with solar. With ShoreStation's solar-powered system, you avoid the need for AC power on your dock, allowing you to focus on what's important - enjoying life's special moments.

**PEACE OF MIND** - Even during a power outage, our solar-powered DC system lifts remain fully functional ensuring there is always power to your lift. What's even better? Solar Powered DC systems last longer and perform better in marine environments.

**EASE OF MAINTENANCE** - With solar-powered lifts, gone are the days of hassling with battery maintenance. Simply plug it in, connect to the battery, and you're ready! Solar power quickly charges the lift battery and then switches to maintenance mode to protect the battery from overcharging - effectively preventing battery drain and maintaining peak power.

The panel can be left on the battery year round eliminating the need to remove it for winter storage.



Defy convention, and push technology to the limits...

# Boats are changing, Lifts are changing with them.

Our unique hydraulic lift design allows you the freedom to choose how you experience owning a lift. The benefits of ShoreStation's Permanent Lifts are endless. With features that allow for greater flexibility in dock design and lift placement, your ShoreStation is key to complementing your waterfront view.

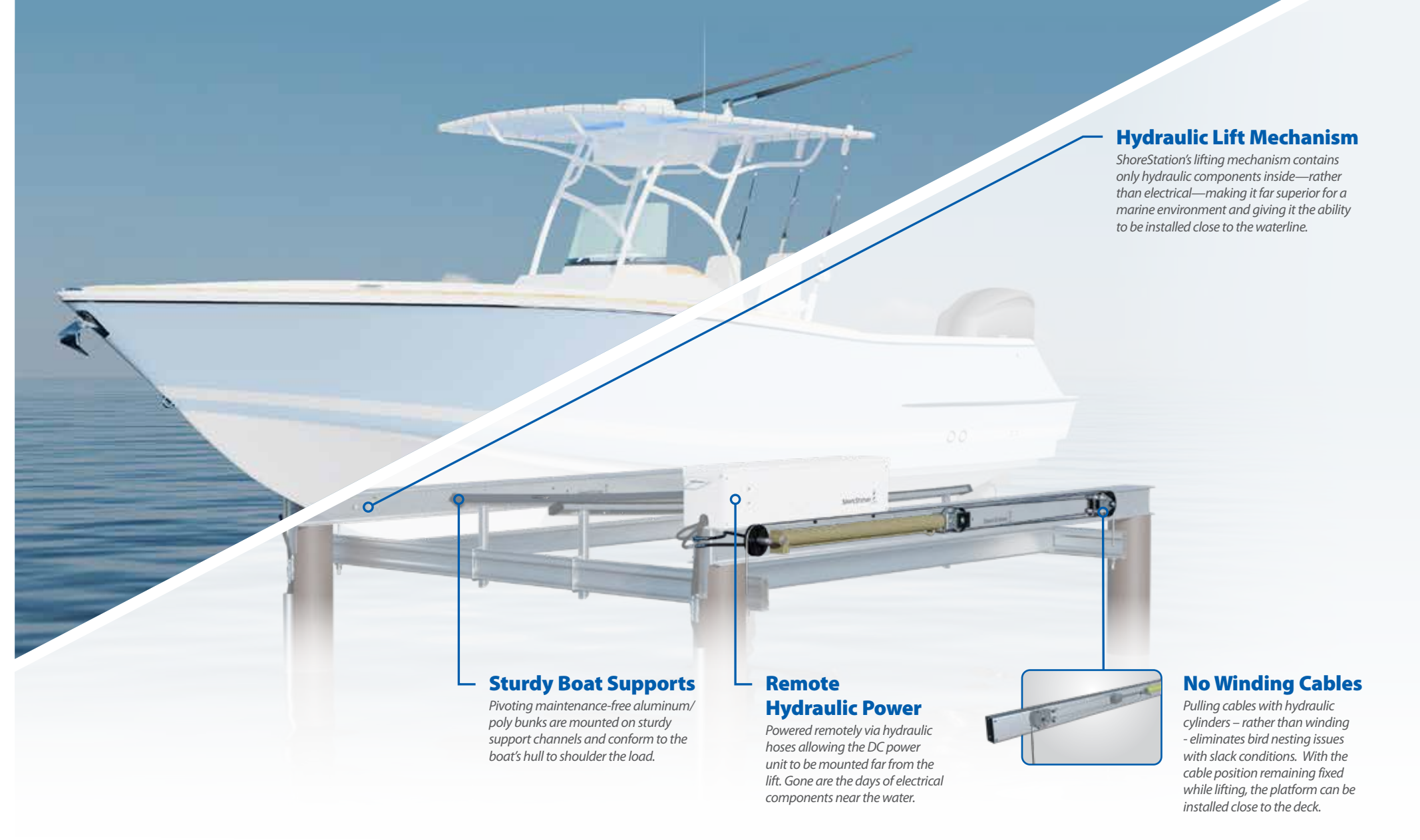

## Hydraulic Lift Mechanism

ShoreStation's lifting mechanism contains only hydraulic components inside—rather than electrical—making it far superior for a marine environment and giving it the ability to be installed close to the waterline.

## Sturdy Boat Supports

Pivoting maintenance-free aluminum/poly bunks are mounted on sturdy support channels and conform to the boat's hull to shoulder the load.

## Remote Hydraulic Power

Powered remotely via hydraulic hoses allowing the DC power unit to be mounted far from the lift. Gone are the days of electrical components near the water.

## No Winding Cables

Pulling cables with hydraulic cylinders – rather than winding – eliminates bird nesting issues with slack conditions. With the cable position remaining fixed while lifting, the platform can be installed close to the deck.

*From simple to sophisticated.  
Overhead to under-deck.*

# **The options are endless!**



*This isn't your typical boat lift!  
Our unique above-the-water  
hydraulic design allows you to  
get creative so your shorestyle  
complements your lifestyle.*

*Install high for tidal  
fluctuation, deck level  
for a low profile look,  
or deck over the platform.  
Hang it from the ceiling,  
hide it in the roof or  
mount it under the deck.*



Up to 6,000 lb capacity.

**SMALL T-SLOT CRADLE**



Up to 8,000 lb capacity.

Up to 10,000 lb capacity.

**LARGE T-SLOT CRADLE**

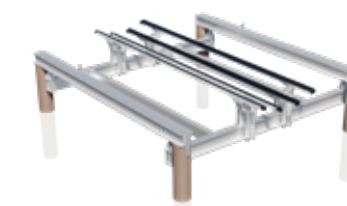

Up to 15,000 lb capacity.

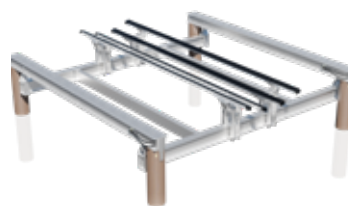

Up to 20,000 lb capacity.



Up to 30,000 lb capacity.

**I-BEAM CRADLE WITH CROSS BRACING BUNK SYSTEM**

# Choose your boat support.

Offering numerous boat support options to protect and support any watercraft. Our Flexible Aluminum/Poly bunks and Poly-Covered ToonRails are both mounted on sturdy support channels to fully shoulder the load.

Capacity in lbs	Part Number	Description	For Platform Length	Bunk Length	Number of Bunks
<b>Boat Supports</b>					
4,000 - 6,000	HA0129	Pair of poly-aluminum bunks w/ hardware	128"	12'	2
8,000	HA0212	Pair of poly-aluminum bunks w/ hardware for I-beam cradles	128"	12'	2
10,000	HA0194	Pair of poly-aluminum bunks w/ hardware	164"	15'	2
15,000 - 20,000	HA0193	Pair of double poly-aluminum bunks w/ hardware	164"	17.5'	4
30,000	HA0269	4 pair of double poly-aluminum bunks w/hardware	159"	4'	8
<b>Pontoon Supports</b>					
4,000 - 8,000	HA0211-66	ToonRail Bunk System: The 3-in-1 under-deck lift support with integrated motor stop and load guides is economical and maintenance free. The contoured poly-covered tubes both guide the pontoon into the lift and support it by simply lifting under the deck inside the outer tubes.			
4,000 - 6,000	HA0224-66	Pontoon Log Rack: The double UltraBunks and full length GlideRail load guides cradle and channel the outer "logs" perfectly every time. The unique kit is designed to work well on both tritoons and standard pontoons.			

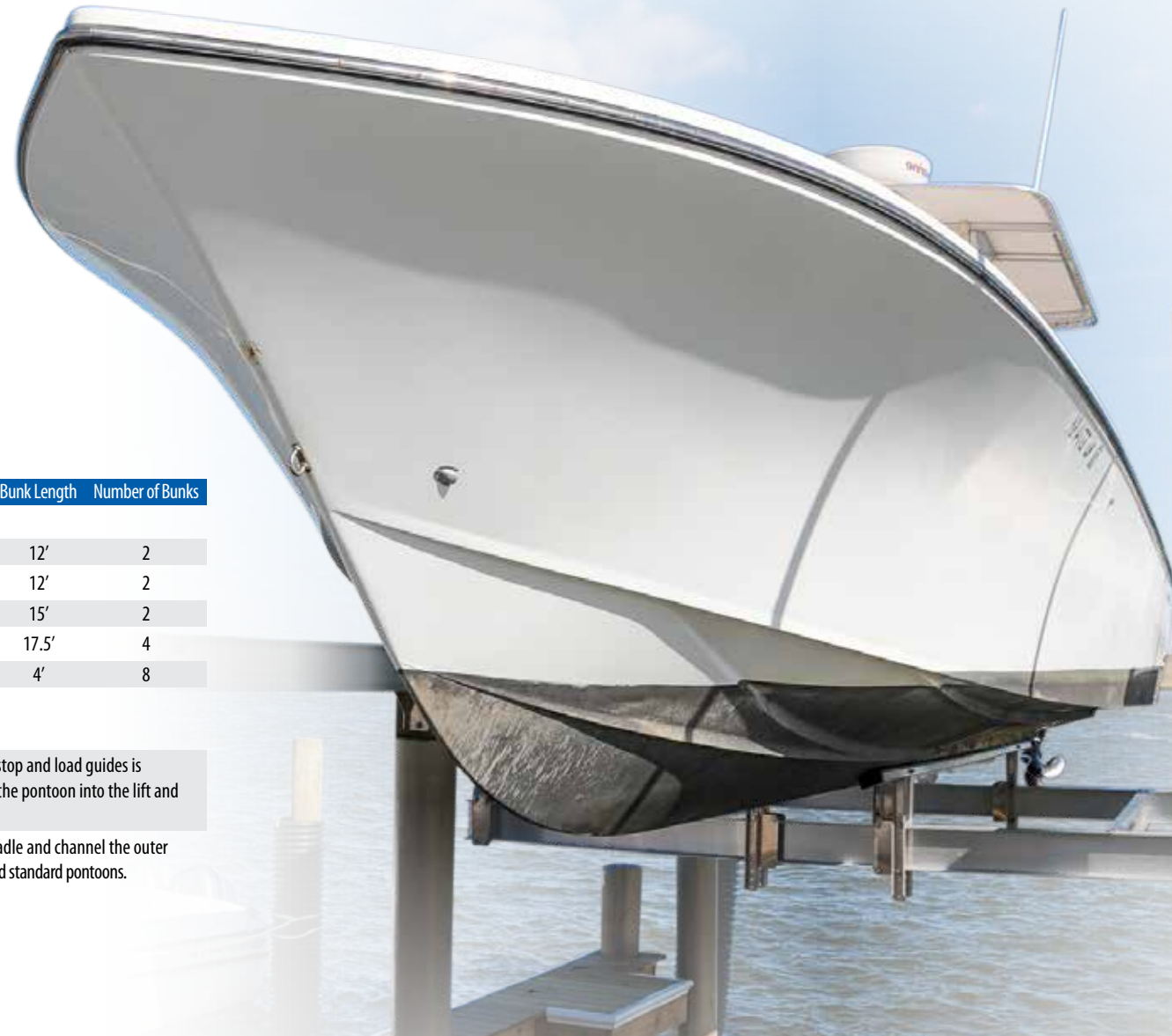

### SINGLE BUNK

Pivoting maintenance-free aluminum/poly bunks are mounted on sturdy support channels to shoulder the load.



### TOONRAIL

The 3-in-1 under-deck lift support with integrated motor stop and load guides is economical and maintenance free. The contoured poly-covered tubes both guide the pontoon into the lift and support it by simply lifting under the deck inside the outer tubes. Available on 4,000 - 8,000 lb lifts.



### LOGRACK

The double UltraBunks and full length GlideRail load guides cradle and channel the outer "log" perfectly every time. The unique kit is designed to work well on both tritoons and standard pontoons with tubes up to 29". Available on 4,000 - 8,000 lb lifts.



### TANDEM BUNK ON 15 & 20

Available with 2 supports that adjust to fit for larger watercraft. Available on 15,000 and 20,000 lb lifts.



### DOUBLE PWC

Designed to fit today's big 3-person watercrafts. The platform & bunks adjust to fit 2 PWC's side by side.



### 2X TANDEM BUNK ON 30K

Available with 4 independent supports that adjust to the fit for the large watercraft while accommodating step hulls often found on larger boats.

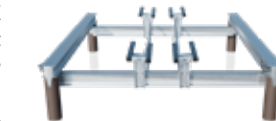

*Bunk supports conform to the boat's hull providing greater support.*





## Boat Guides

Centering your craft in the lift and holding its position until the platform rises can be intimidating—especially in wind and waves. To help ease the stress of loading a vessel, we developed an extensive line of poly covered loading aides.

Part Number	Description
HA0170-66	Pair of 10 ft. Post Load Guides for 4,000-30,000 lb lifts. Keeps the boat bow centered when landing in high wind or waves. Mounts on the lift platform to provide full adjustability.
HA0190-66	Pair of GlidePole Post Load Guides (vertical posts mounted to piling 3"X 148"). Mounts on the corner piling to provide visual aid and guidance when centering and landing your boat on the lift. The durable aluminum core with non-marring UV stable poly sheath are sure to protect your boat while absorbing repeated shocks.
HA0255-66	Pontoon Post Load Guides. One pair of round 23" high, poly-covered steel posts; fits 4,000 & 6,000 lb "Flat Tube" Cradle Lifts.



## Boat Stops

Bring your boat to a stop in the perfect position every time. These bow and motor stops will help prevent your boat from overrunning the lift. Available for the following sizes.

Part Number	Description
HA0087	Motor Stop kit w/ hardware for 4,000 - 6,000 lb lifts
HA0098	Bow Stop Kit for 4,000 - 6,000 lb lifts
HA0217	Bow Stop Kit for 8,000 - 10,000 lb lifts

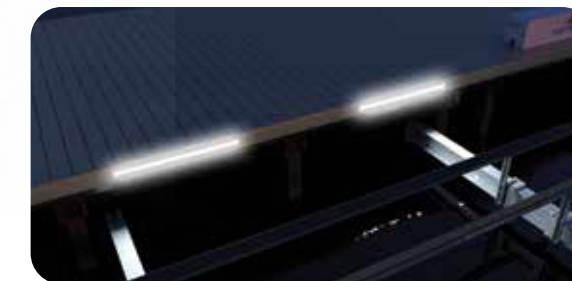

## Lighting

**LED STRIP LIGHT KIT -**  
Two 39", super bright, 24V light strips mounted on the lift's tube or pilings for safety at night. Effortlessly controlled using your lift's wireless remote.

Part Number - HA0220

# ShoreScreen

From covered to uncovered in seconds. Protect your boat with this high-tech screen.

**THE ULTIMATE IN BOAT PROTECTION** - Protect your boat from damaging UV rays, and create a barrier against wind-blown debris, insects and birds to ensure your boat stays in showroom condition. No more hassling with traditional heavy boat covers and snaps.

**FAST, TROUBLE-FREE OPERATION** - Two drive motors positioned on opposite corners roll all four screens simultaneously without complicated cables or pulleys. The adjustable limit stop allows the user to preset desired heights.

**SUN-CONTROL SCREENING WITH MICROBAN** - The black SunTex 80 woven mesh gives the ShoreScreen a subdued shadowy effect. It absorbs and dissipates up to 80% of the sun's heat while allowing air flow. The microban technology prevents mildew build-up when rolled up.

**CONVENIENT WIRELESS OPERATION** - Simply push a button on the remote and the cover quickly raises and lowers over your boat. You can even use the same remote for both your lift and ShoreScreen.



**360° Protection**

Fully unrolled, the curtain is 7 ft long



SEE THE SHORESCREEN IN ACTION



**WIRELESS OPERATION**  
12V DC motors use the boat lift battery and is controlled with the same remote as your lift.

**MODULAR DESIGN**  
Curtain panels mount directly to boat house roof or side of pilings with adaptable brackets (included).

# REVOLUTION Series Canopy

Eliminate the folding, lifting, and tugging with our 'Roll and Store' canopy design. Simply unroll, cover the frame, and lock into place with our patented locking system for a taut, fully secured canopy.

**MORE PROTECTION AND COVERAGE** - The deep 20" rigid canopy frame and 7' ShoreScreen gives you complete protection from the elements with nearly 9' of vertical coverage. The trussed side frame provides strength and durability, along with the classic appearance ShoreStation canopies are known for.

**PREMIER TEXTURED COVER** - Our canopy cover features a vinyl-coated polyester fabric for long-lasting protection, durability, and weatherproofing. The waterproof textured matte finish provides the rich look of fabric with the unmatched durability of vinyl.

**AVAILABLE SIZES**

Length: 20 - 36 ft  
Width: 100 - 144 in

**VINYL CANOPY COVER COLOR OPTIONS**





# Compare the features and discover why ShoreStation is a far superior value!

Our revolutionary hydraulic design utilizes DC power to provide the fastest lift speeds on the market. Cables cannot be overwound or unspooled maximizing cable life, safety, and your time spent on the water.

**The result...the fastest, safest, most reliable boat lift on the market!**

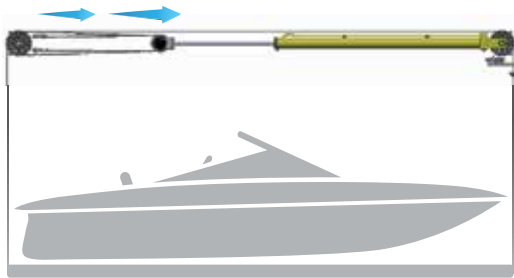

Cables pulled not wound

VS.

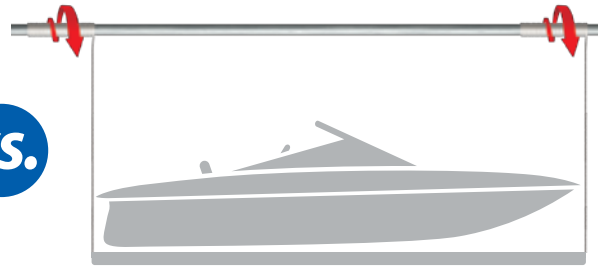

Cables wound around pole or winch drum

ShoreStation Hydraulic	Comparison Chart	Traditional Cable Winder
Up to 96" per minute*	<b>Speed</b>	Up to 40" per minute
Cannot overwind or unspool	<b>Cable Protection</b>	Easily unspool if cable goes slack
Safe Reliable DC with Solar Panel	<b>Power Source</b>	AC Circuit Required
15/6/3 Year Manufacturer's Warranty	<b>Warranty</b>	1 year
Hassle-free cable design, corrosion resistant materials, stainless cables and hardware	<b>Maintenance</b>	Annual inspections, cable greasing, re-string cables
Tandem pump auto levels	<b>Level Lifting</b>	Manual intervention to keep level
2 Key FOB remotes standard	<b>Wireless Operation</b>	Unavailable or upcharge
Corrosion free poly/aluminum UltraBunks conform to hull	<b>Bunk Support</b>	Rigid carpeted wood bunks

\*Speed varies by model and load

# Performance Driven Freestanding Lifts

## ShoreStation Boat Lifts

Whether you're looking for one of the safest, most dependable lifts on the market like the ShoreStation Hydraulic, or the simplicity of our original manual drive lift, ShoreStation continues to elevate the industry standards.

Made from the highest quality materials, our innovative hydraulic boat lift is one of the fastest and safest lifts on the market today. When you have a hydraulic lift, there's no need to worry about wind and waves getting in your way. This lift will give you confidence to safely land and secure your boat in less than ideal conditions.

